



**LinkSprite JPEG Color Camera  
Serial UART Interface**

**User Manual**

**March , 2012**

**LinkSprite Technologies, Inc**

**[www.linksprite.com](http://www.linksprite.com)**

<b>Doc Title</b>	LinkSprite JPEG Color Camera Serial UART Interface User Manual	<b>Number</b>	LS-Y201
		<b>Version</b>	1.1

<b>Version</b>	<b>Date</b>	<b>Description</b>	<b>Author</b>
1.1	31/03/2012	The second edition	Nancy

## Table of Content

1. Introduction.....	4
2. Specification .....	4
3. Application.....	5
4. Getting Started - TTL.....	5
4.1 Hardware part.....	5
4.2 Hardware connection.....	6
5. Getting Started——RS232 .....	6
5.1 Hardware part.....	6
5.2 Hardware connection.....	7
5.3 Hardware connection.....	8
5.4 Software .....	8
6. Test.....	8
6.1 Regular test.....	8
6.2 Software .....	9
6.3 Test with software .....	11
6.4 Test with X-CTU.....	12
7. Communication Protocol .....	12
7.1 Reset.....	12
7.2 Take picture.....	13
7.3 Read JPEG file size.....	13
7.4 Read JPEG file content .....	13
7.5 Stop taking pictures.....	13
7.6 Compression Ratio .....	14
7.7 Image size.....	14
7.8 Power Saving.....	14
7.9 Changing Baud Rate.....	15
8. Program flow chart .....	16
8.1 Initialize.....	16
8.2 Take JPEG picture: .....	17

## 1. Introduction

LS-Y201 is LinkSprite's new generation serial port camera module. It can capture high resolution pictures using the serial port. LS-Y201 is a modular design that outputs JPEG images through UART, and can be easily integrated into existing design.

## 2. Specification

- I VGA/QVGA/160\*120 resolution
- I Support capture JPEG from serial port
- I Default baud rate of serial port is 38400
- I DC 3.3V or 5V power supply
- I Size 32mm X 32mm
- I Current consumption: 80-100mA
- I Near the C03 pin is AV output, this is a analog output pin.

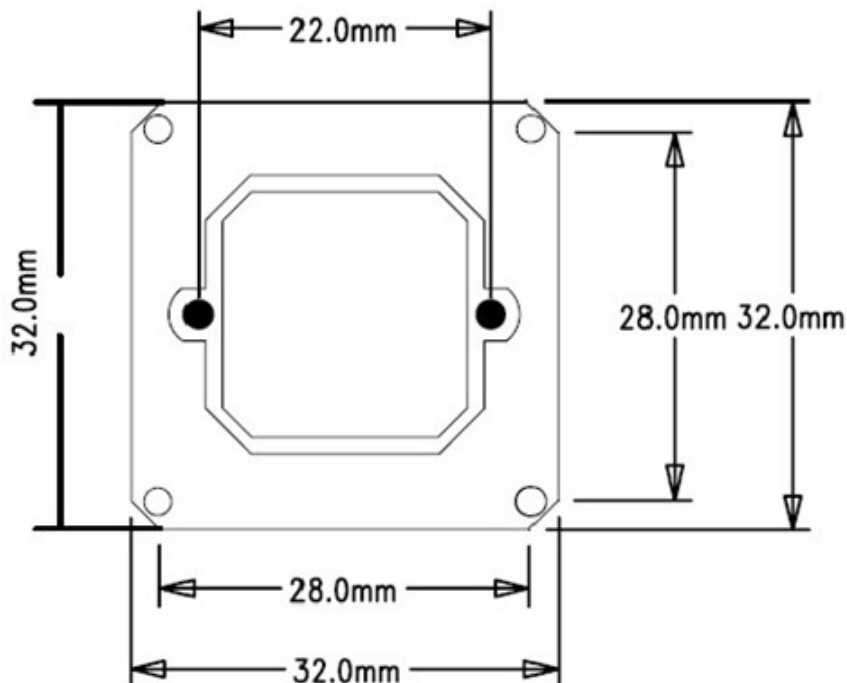

Footprint

### 3. Application

- I Different image capture systems
- I Environmental monitoring
- I Industry monitoring
- I Medical equipment
- I Video phone
- I Security
- I Vehicle based GPS

### 4. Getting Started - TTL

#### 4.1 Hardware part

- I LS - Y201 – TTL camera

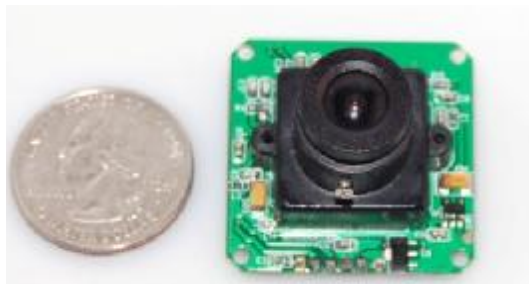

- I 5V DC power
- I UART-USB module



## 4.2 Hardware connection



- I LS - Y201 - TTL (TXD) to UART-USB (RXD).
- I LS - Y201 - TTL (RXD) to UART-USB (TXD).
- I LS - Y201 - TTL (GND) to UART-USB (GND). At the same time it also need to connect to GND in power.
- I LS - Y201 - TTL (VCC) to +5V DC power.
- I UART-USB module and DB9 needle connected to each, and DB9 hole connected to PC。

## 5. Getting Started——RS232

### 5.1 Hardware part

- I LS - Y201 - RS232 camera
- I 5V DC power
- I RS-232 serial cable (DB9 MALE/FEMALE)

## 5.2 Hardware connection

- I LS - Y201 - RS232 (TXD) to DB-9 MALE pin 2(RXD).
- I LS - Y201 - RS232 (RXD) to DB-9 MALE pin 3(TXD).
- I LS - Y201 - RS232 (GND) to DB-9 MALE pin 5(GND). At the same time it also need to connect to GND in power.
- I LS - Y201 - RS232 (VCC) to +5V DC power.

Note: If you are using DB-9(FEMALE), the 2 pin is TXD, the 3 pin is RXD.

DB-9 Pin definition

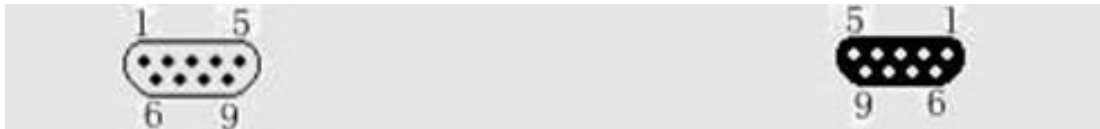

DB-9 MALE(Needle)

DB-9 FEMALE(Hole)

- I RS-232 (DB-9 FEMALE / Hole) Pin definition

Pin number:            2            3            5            1. 4. 6            7. 8

Signal definition: TXD    RXD    GND    Internal connected    Internal connected

Directly connect the COM port of PC

- I RS-232 (DB-9 MALE/ Needle) Pin definition

Pin number:            2            3            5            1. 4. 6            7. 8

Signal definition: RXD    TXD    GND    Internal connected    Internal connected

Directly connect the COM port of PC

### 5.3 Hardware connection

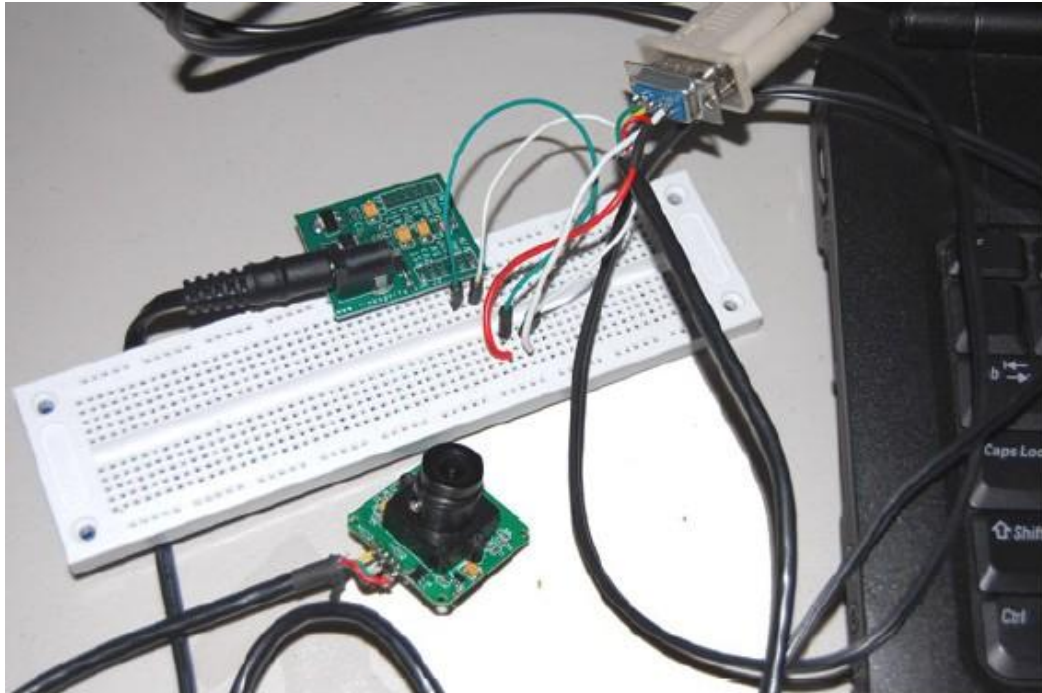

### 5.4 Software

I X-CTU Download Link: [www.digi.com](http://www.digi.com) (test software)

I Software:

<http://www.linksprite.com/download/showdownload.php?id=36&lang=en>

## 6. Test

### 6.1 Regular test

Power up information in X-CTU as the following ASCII:

Please note that the baud rate should be 38400.





## 6.2 Software

Com Port: Choose the right Com Port.

Data Port: Baud Rate settings, here it is 38400.

Click “Open” to open Com connection

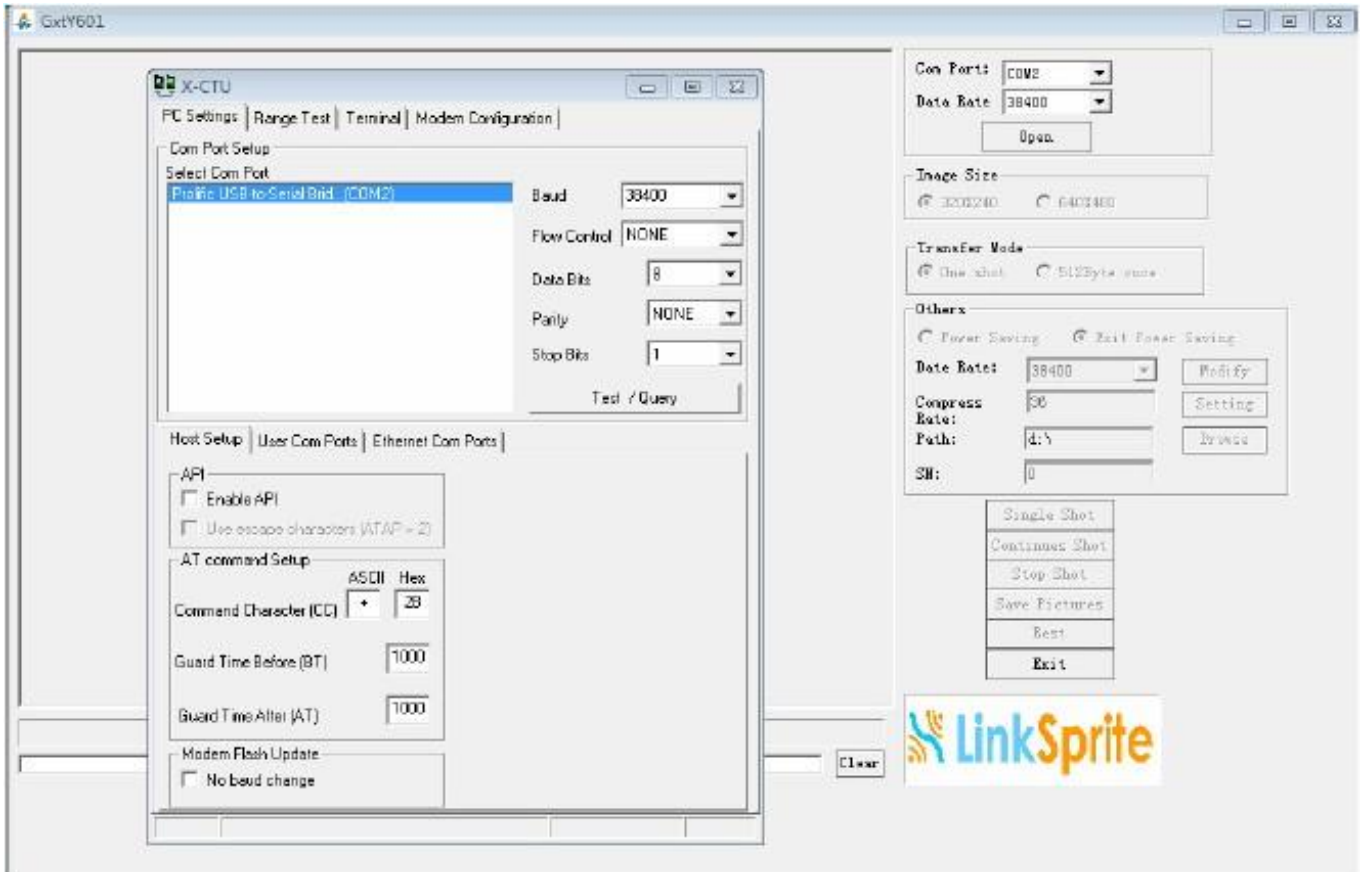

Path: Set the path for captured images. Please note that it is necessary to set the path, if it is a wrong path or not exist, then the picture may not be saved.

### 6.3 Test with software

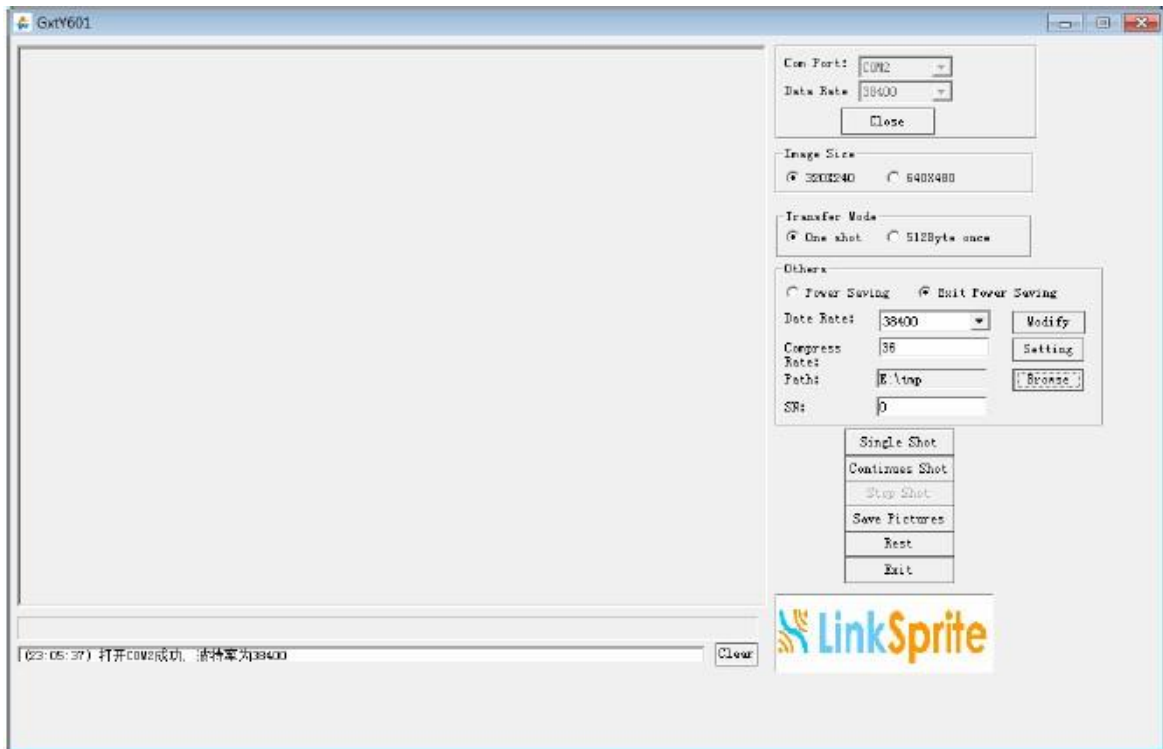

Click “Single Shot”:

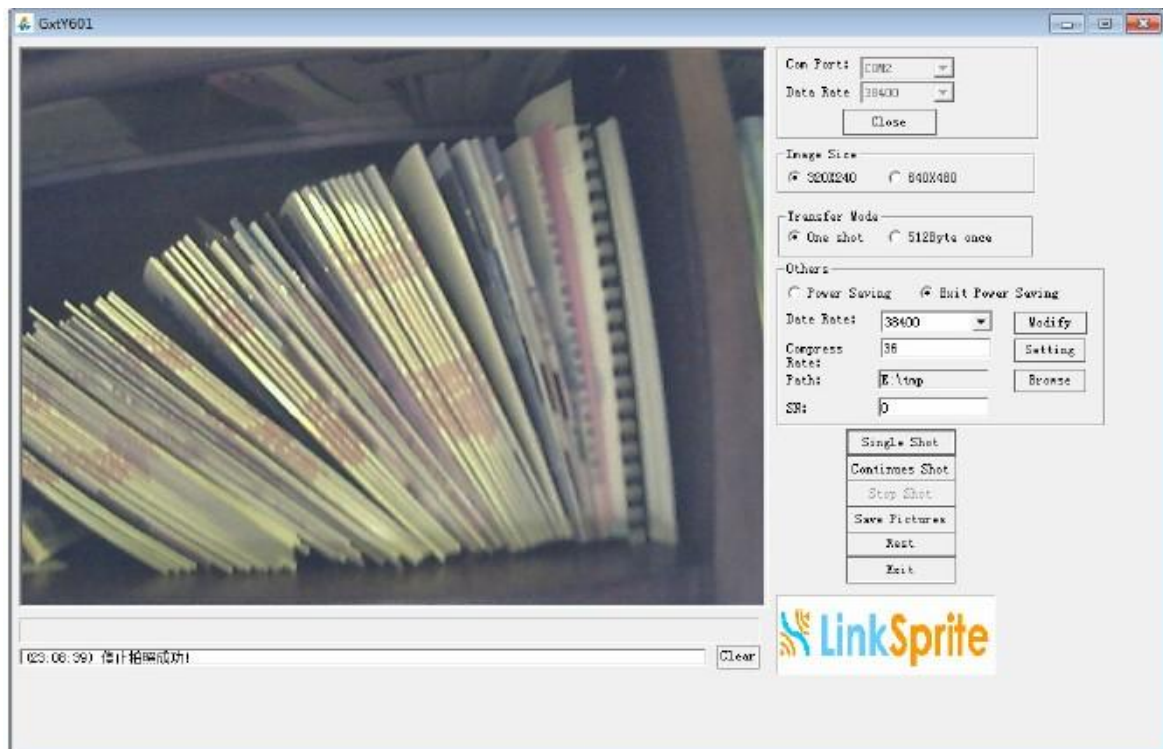

## 6.4 Test with X-CTU

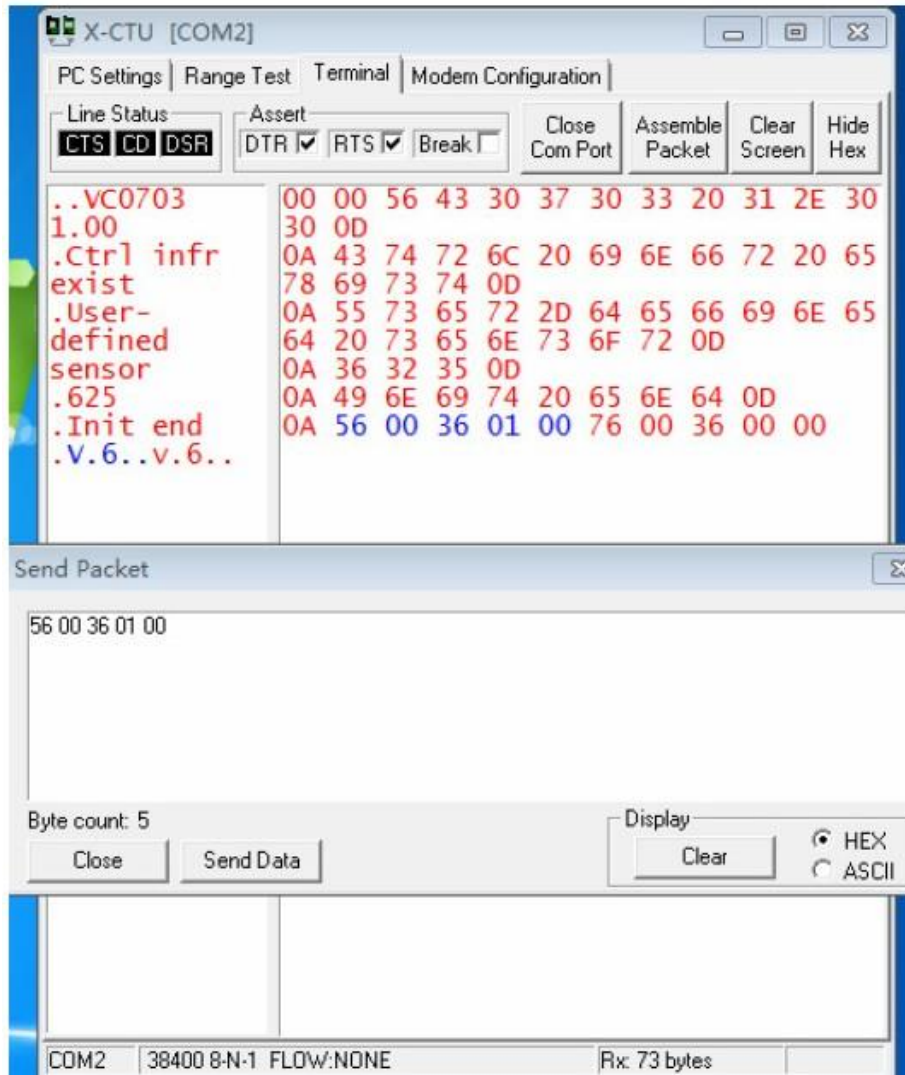

Input HEX command in “Send Packet” and click “Send Data”, X-CTU will show the input command and return the information sent back by the camera.

## 7. Communication Protocol

### 7.1 Reset

Send: 56 00 26 00

Return: 76 00 26 00

## 7.2 Take picture

Send: 56 00 36 01 00

Return: 76 00 36 00 00

## 7.3 Read JPEG file size

Read length: 56 00 34 01 00

Return : 76 00 34 00 04 00 00 XH XL

XH XL is the length of the picture file, MSB in the front and LSB in the end.

## 7.4 Read JPEG file content

Read: 56 00 32 0C 00 0A 00 00 MM MM 00 00 KK KK XX XX

Return : 76 00 32 00 00 (Spacing Interval) FF D8    . . . . . (Spacing Interval)

76 00 32 00 00

(spacing interval) = XX    XX\*0.01ms

00 00 MM MM Init address

00 00 KK KK data length

MSB first, then LSB

Note: (Spacing Interval) = XX    XX\*0.01ms, it is better to be smaller, such as:

00 0A

JPEG file start from FF D8 end by FF D9.

To read Jpeg file, the start is always 0000, and read data block in integer multiple of 8 till it show FF D9 at the end.

## 7.5 Stop taking pictures

Stop : 56 00 36 01 03

Return : 76 00 36 00 00

## 7.6 Compression Ratio

Send: 56 00 31 05 01 01 12 04 XX

Return: 76 00 31 00 00

XX is usually 36, XX: 0X00 to 0XFF, XX is about Compression Ratio, the bigger it is, the more compressed of the picture.

## 7.7 Image size

Command 1 :

Send		Return
56 00 31 05 04 01 00 19 00	(640*480)	76 00 31 00 00
56 00 31 05 04 01 00 19 11	(320*240)	76 00 31 00 00
56 00 31 05 04 01 00 19 22	(160*120)	76 00 31 00 00

When changing the size, it needs to be reset or reconnect power, once it has been changed, the parameters will remain even disconnect power.

Command 2:

Send		Return
56 00 54 01 00	(640*480)	76 00 54 00 00
56 00 54 01 11	(320*240)	76 00 54 00 00
56 00 54 01 22	(160*120)	76 00 54 00 00

Do not disconnect or reset after sending the command, or it will turn back to 320\*240.

## 7.8 Power Saving

Send: 56 00 3E 03 00 01 01      Return : 76 00 3E 00 00

Quit Saving: 56 00 3E 03 00 01 00    Return: 76 00 3E 00 00

## 7.9 Changing Baud Rate

Send : 56 00 24 03 01 XX    XX

Return : 76 00 24 00 00

XX	XX	baud rate
AE	C8	9600
56	E4	19200
2A	F2	38400
1C	4C	57600
0D	A6	115200 (Max)

Please Note:

- I The starting read address must be the 8 integer multiples
- I For multiple cameras 56 XX 36 01 00, XX is the Device Number( Default is 00 )
- I UART is in RS232 level. If connect to the MCU, please add a level converter or remove the MAX3232 ic. RS232 level are used in the modules, UART communication distance can not be longer than 1m.
- I The serial port will show the below info when connect with power:  
  
Ctrl infr exist  
  
User-defined sensor  
  
625  
  
Init end
- I The host only have to make sure when to receive “Init end” (36 32 35 0D 0A 49

6E 69 74 20 65 6E 64 0D 0A) , then take the capture command in 2-3s.

## 8. Program flow chart

### 8.1 Initialize

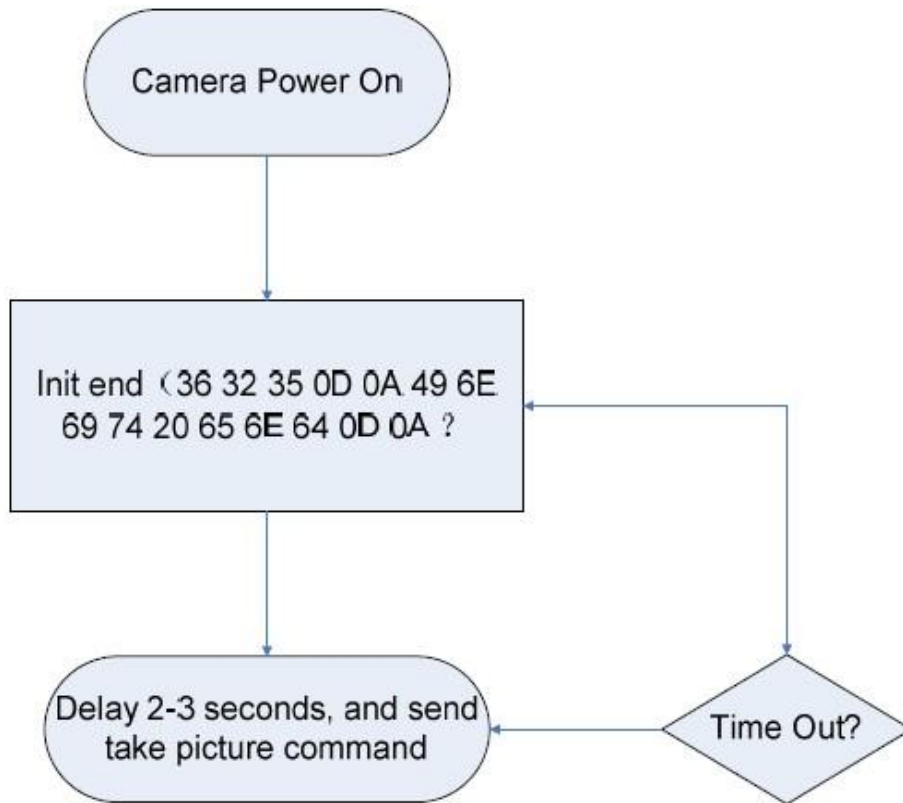



## 8.2 Take JPEG picture:

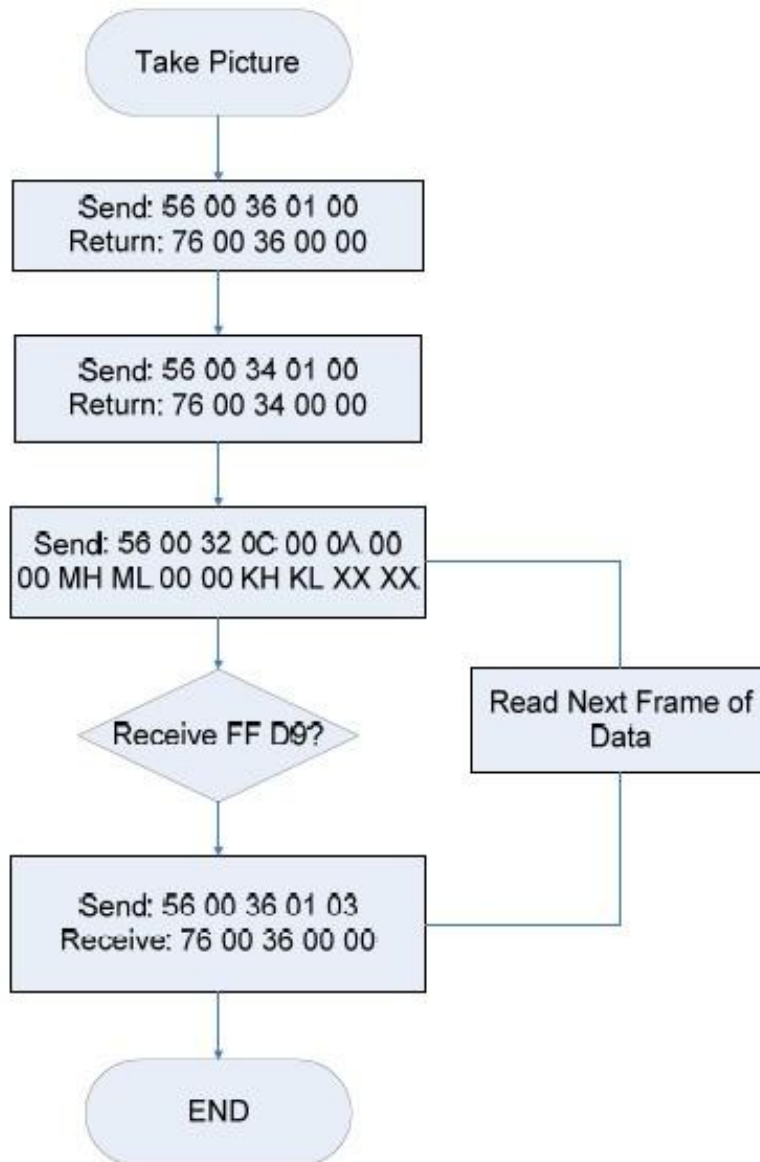

LinkSprite Technologies, Inc.

Add: 1067 S Hover St, Unit E-186, Longmont, CO 80501

Tel: 720-204-8599

Email: [sales@linksprite.com](mailto:sales@linksprite.com)

Web: [www.linksprite.com](http://www.linksprite.com)

