



ESPRESSIF SYSTEMS

— The Complete IoT Solutions Provider —

Connect :: Innovate





Company Introduction

Technology

We design groundbreaking
Wi-Fi + Bluetooth chips

Innovation

Our products are engineered
to drive innovation

Community

Our products are supported by
thousands of enthusiastic developers

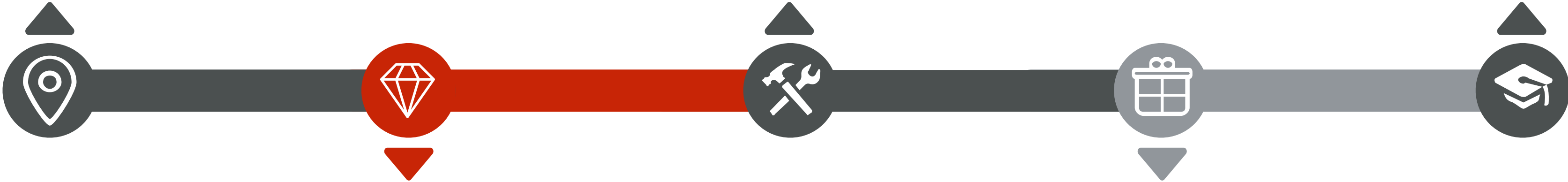

High Integration

Our designs pack all your
design requirements in a single SoC

Complete Solution

We have the complete package:
Hardware, software, app and cloud!



Our Journey

ESP8089 RELEASED

Highly integrated Wi-Fi chip with optimal performance



2013

FOCUS ON TECHNOLOGICAL PROGRESS

Over 100 engineers from across the world are employed and committed to technological innovation and progress



2014



2016

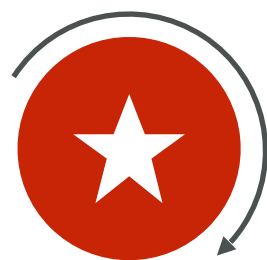

ESP32 RELEASED

Realizing developers' dream, ESP32 is engineered for the future of IoT and wearable tech

FOUNDED IN 2008



ESP8266 RELEASED

Game-changer in the IoT industry

NEXT MILESTONE



Honors & Recognitions

2015



Red Herring
2015 Red Herring
Top 100 Asia Award

Prestigious award
honoring the most
promising private
technology ventures
in Asia in 2015



2016



O'Reilly

Espressif's ESP8266 is
featured in a series of
books published by this
renowned media
company

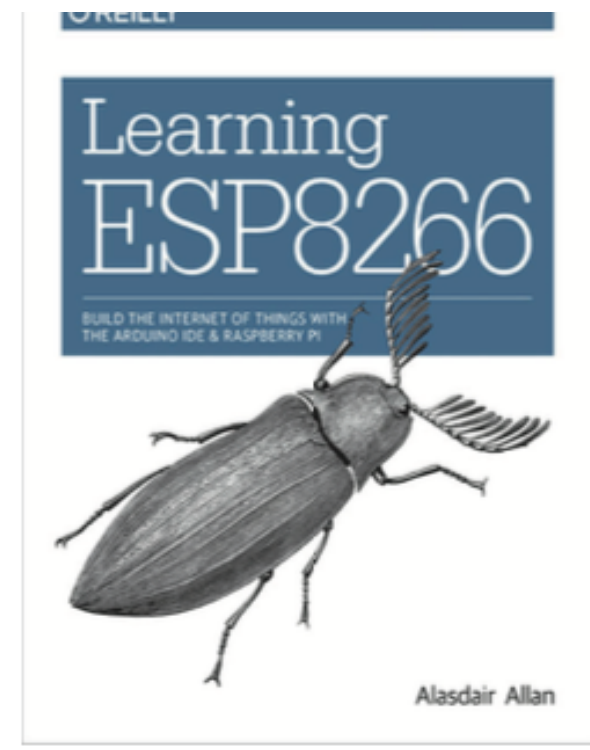

2016



Gartner Cool Vendor

This world-leading
information technology
research and advisory
company characterizes
Espressif as the IoT
industry's "Cool Vendor"
in 2016



2016



Best IC Design

ESP8266EX wins an
award for the
"Best Wireless/RF IC" at
the 2016 Greater China
IC Design Awards





Ecosystem

POPULAR DEVELOPMENT PLATFORMS

Arduino IDE, Smart.JS, NodeMCU, MicroPython, Mongoose OS

THIRD-PARTY CLOUD PLATFORMS

Up to 30 mainstream cloud platforms support Espressif Products

<http://www.espressif.com/zh-hans/ecosystem/cloud-platform>

PUBLICATIONS

- Alasdair Allan, *Learning ESP8266* (O'Reilly)
- Neil Kolban, *Kolban's Book on ESP8266*
- Marco Schwartz, *Internet of Things with ESP8266*
- Rui Santos, *Home Automation with ESP8266*
- 部員三号, *ESP8266ではじめるIoTプログラミング*
- Hasbi Sevinc, *ESP8266 ve Arduino ile Nesnelerin interneti*
- Claus Kuhnel, *Building an IoT Node for less than 15 \$: NodeMCU & ESP8266*

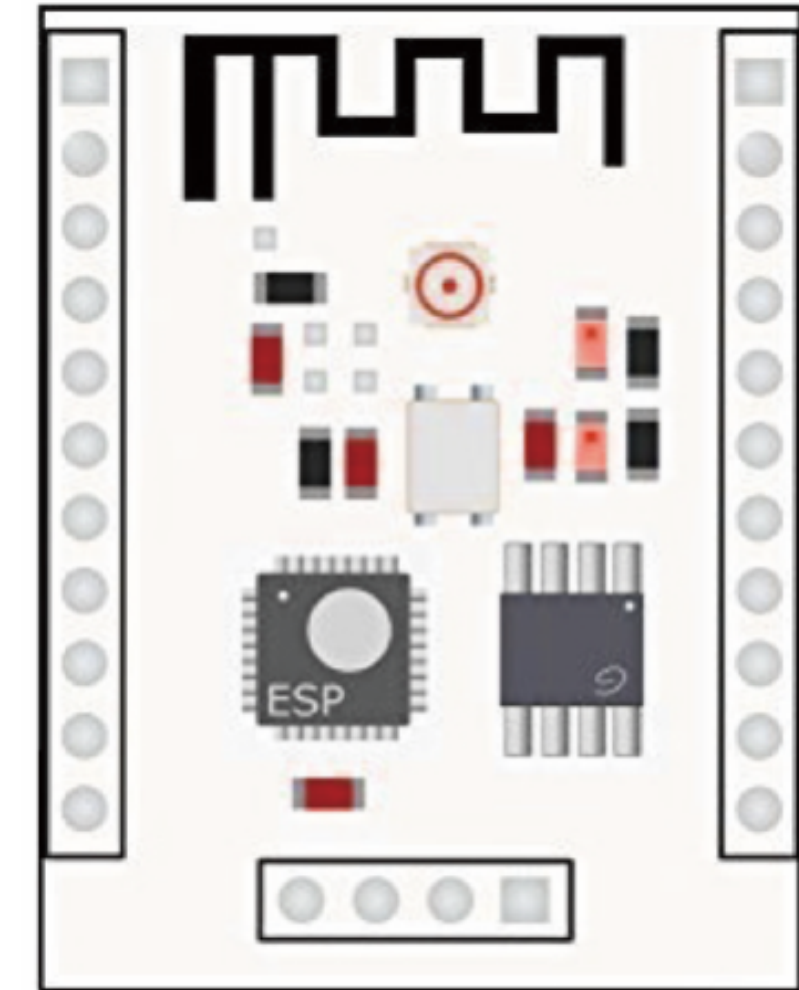



Product Tree

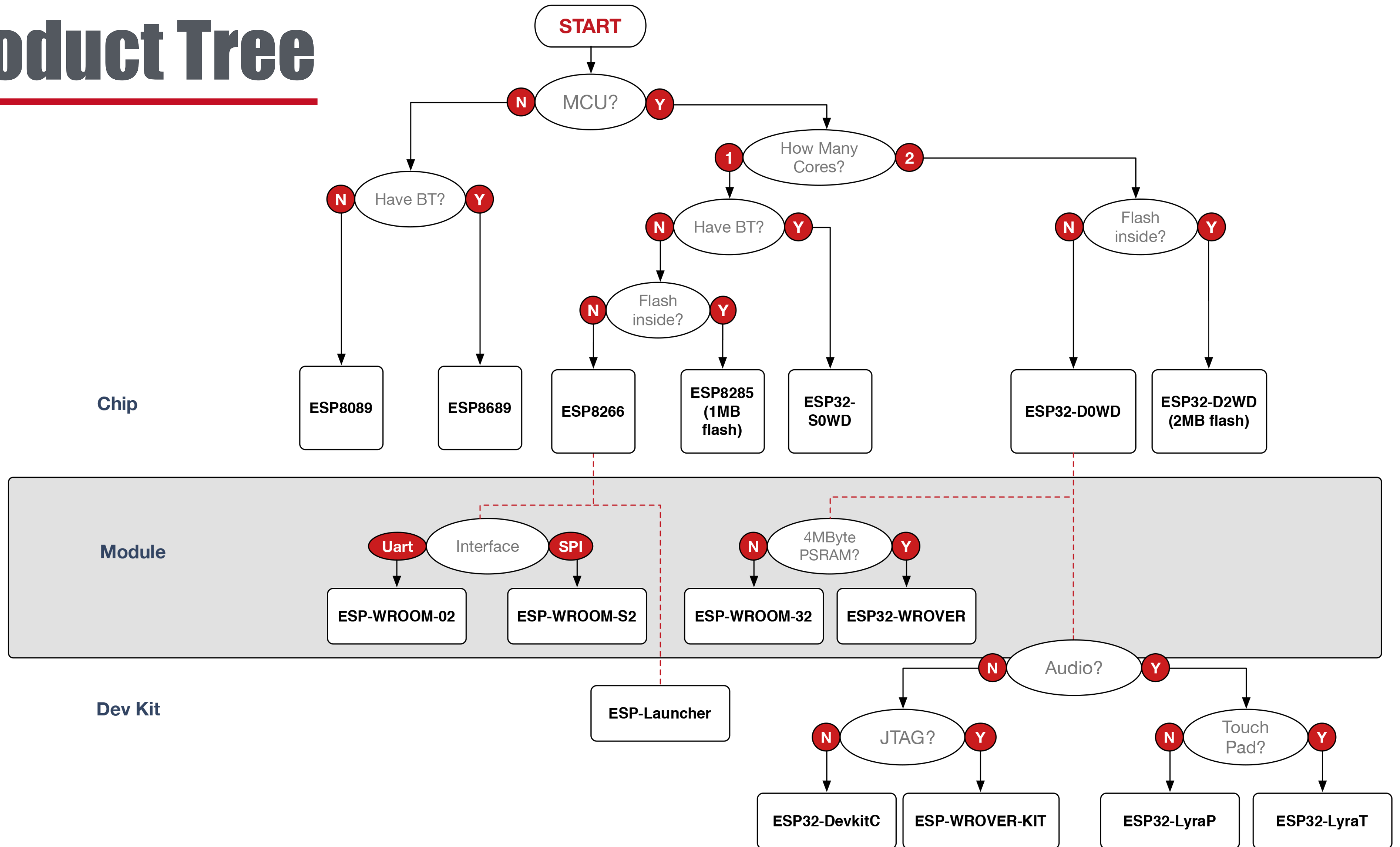



ESP32 Family

ESP32-D0WDQ6

CPU:	Xtensa® 32-bit LX6 dual-core processor, up to 600 DMIPS
Faster Wi-Fi:	802.11 b/g/n Wi-Fi, upgraded to HT40
Bluetooth:	Support for Classic Bluetooth and BLE v4.2
Memory:	520-KB SRAM 448-KB ROM 16-KB SRAM in RTC
Security:	Support for AES, HASH (SHA-2), RSA, ECC, RNG and flash encryption
Low power:	5 μ A sleep, support for five low-power modes
Rich Peripherals:	10 \times capacitive touch pads, 12-bit SAR ADC (18 channels), 8-bit DAC, Hall sensor, temperature sensor, I2C, I2S, UART, SPI, host SDIO/eMMC, slave SDIO/SPI, CAN2.0, dedicated DMA, Ethernet MAC interface, Motor PWM, LED PWM (16 channels) etc.



- ESP32 is all about versatility. The processor delivers up to 600 DMIPS, clocked at 240 MHz. The hardware peripherals allow efficient interfacing with a wide range of sensors. Engineered for the modern IoT, the power management profiles of ESP32 enable its adaption to any kind of power source.
- Whether it is about wearable tech or real-time secure video streaming, ESP32 is the SoC of choice!
- For information on other members of the ESP32 family, please refer to the ordering information in [ESP32 Datasheet](#).



ESP-WROOM-32 & ESP32-WROVER



- ▶ **ESP-WROOM-32** is a low-power Wi-Fi + BLE module that integrates the ESP32-D0WDQ6, a 32-Mbit code flash memory and a PCB antenna.
 - The current consumption in sleep mode can be as low as **5 μ A**.
 - ESP-WROOM-32 is a low-footprint, PCB-mountable SMD module that makes all the essential pins available for user application.
 - Easy product certification with the entire RF system is contained in one package!
 - ESP-WROOM-32 has gained SRRRC (China) / FCC (US) / CE (EU) / KC (South Korea) / IC (Canada) / NCC (Taiwan) / TELEC (Japan) / Wi-Fi CERTIFIED™ Interoperability certificates.

- ▶ **ESP32-WROVER** is a super module that integrates a 32-Mbit SRAM and 32-Mbit flash. It is an ideal choice for Wi-Fi audio applications.



ESP32 Development Board

▶ **ESP32-DevKitC**

ESP32-DevKitC is a small-sized ESP32-based development board. The I/O pins are led out to the pin headers on both sides for easy interfacing.

▶ **ESP-WROVER-KIT**

ESP-WROVER-KIT is compatible with ESP-WROOM-32 and ESP32-WROVER. It features support for an LCD and MicroSD card.

▶ **ESP32-LyraP /Audio development board with physical buttons**

The Lyra-series development boards are designed specifically for audio applications. The series integrate core components relevant to audio processing applications.

▶ **ESP32-LyraT / Audio development board with touch pads**

The ESP32-LyraT audio development board exploits ESP32's touch sensing capabilities to the maximum.



ESP32-DevKitC

ESP32-DevKitC

- Developers' choice, with dimensions of 27.9 mm × 48.2 mm
- It is the core board based on ESP32. All I/O pins are led out to the pin headers, which facilitate prototyping with a variety of peripherals as required.
- ESP32-DevKitC is breadboard-friendly with 0.1" headers.

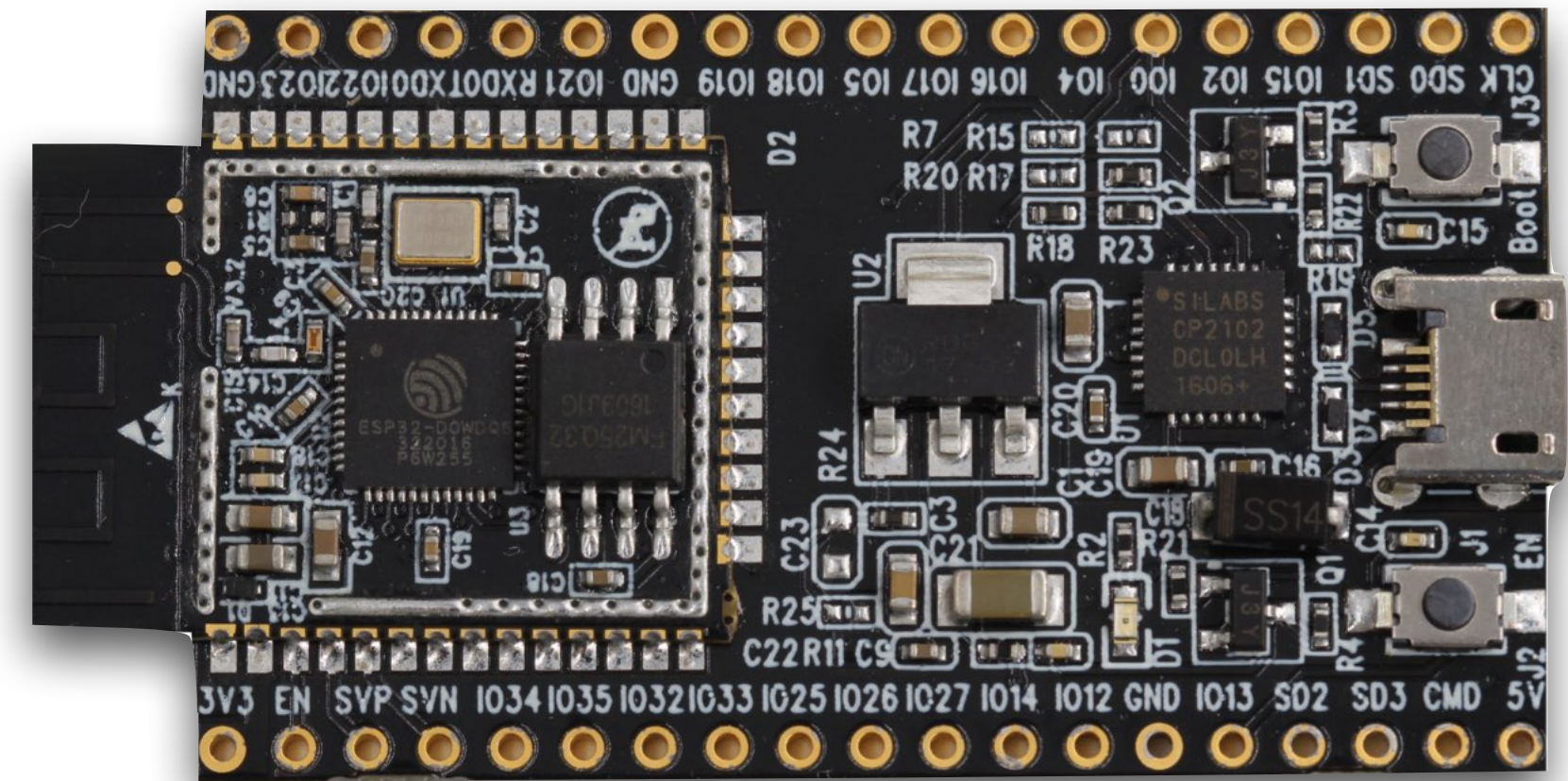



ESP-WROVER-KIT

ESP-WROVER-KIT

- The ESP-WROVER-KIT is a newly-launched development board built around ESP32.
- The I/O pins have been led out from the ESP32 module for easy extension. The board carries an advanced multi-protocol USB bridge (the FTDI FT2232HL), enabling developers to use JTAG directly to debug the ESP32 through the USB interface. The development board makes secondary development easy and cost-effective.

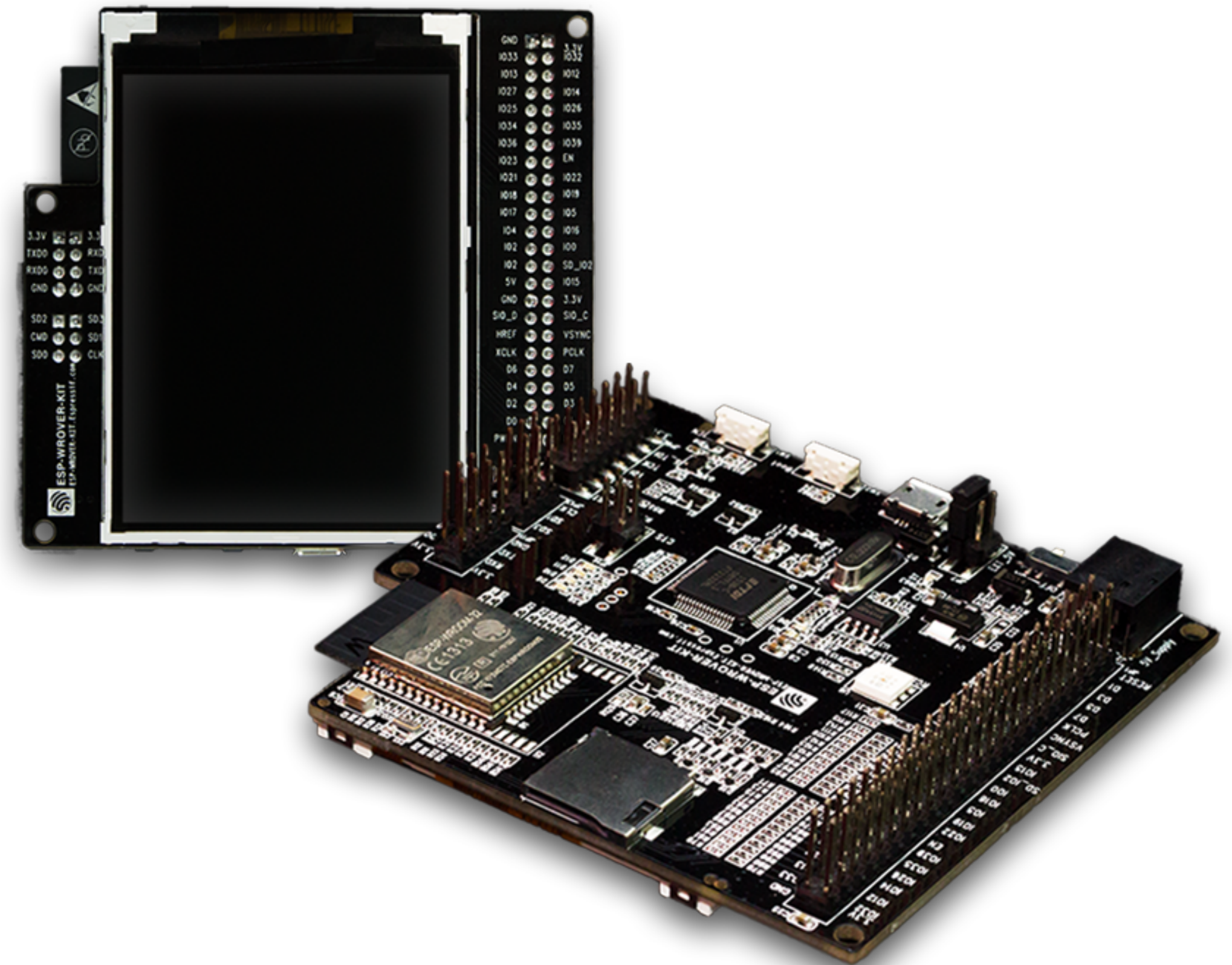



ESP8266 & ESP8285

▶ **ESP8266** is a low cost, highly integrated 32-bit MCU chip, designed to meet the needs of wirelessly-connected products.

- CPU:** Xtensa® L106 32-bit core, running at up to 160 MHz
- Wi-Fi Radio:** IEEE 802.11 b/g/n
- Memory:** 96-KB (dRAM) + 64-KB (iRAM)
- Low Power:** As low as 20 μ A of current consumption in Deep-sleep
- Low Cost:** One of the most cost-effective SoCs for IoT design
- Superior Hardware:** High-speed peripherals such as SPI, I2S, GPIO

- The powerful Xtensa core on the SoC is seamlessly integrated with hardware peripherals, and is focused on low power and high performance. ESP8266 can interface with sensors and other devices, enhancing the overall system performance and code efficiency.
- ESP8266 is highly integrated and requires only seven external components, minimizing the PCB area required and bringing down the BOM cost.

▶ **ESP8285** differs from ESP8266 in that it integrates an 8-Mbit flash, thus reducing the PCB footprint, and making it an ideal choice for wearable devices.

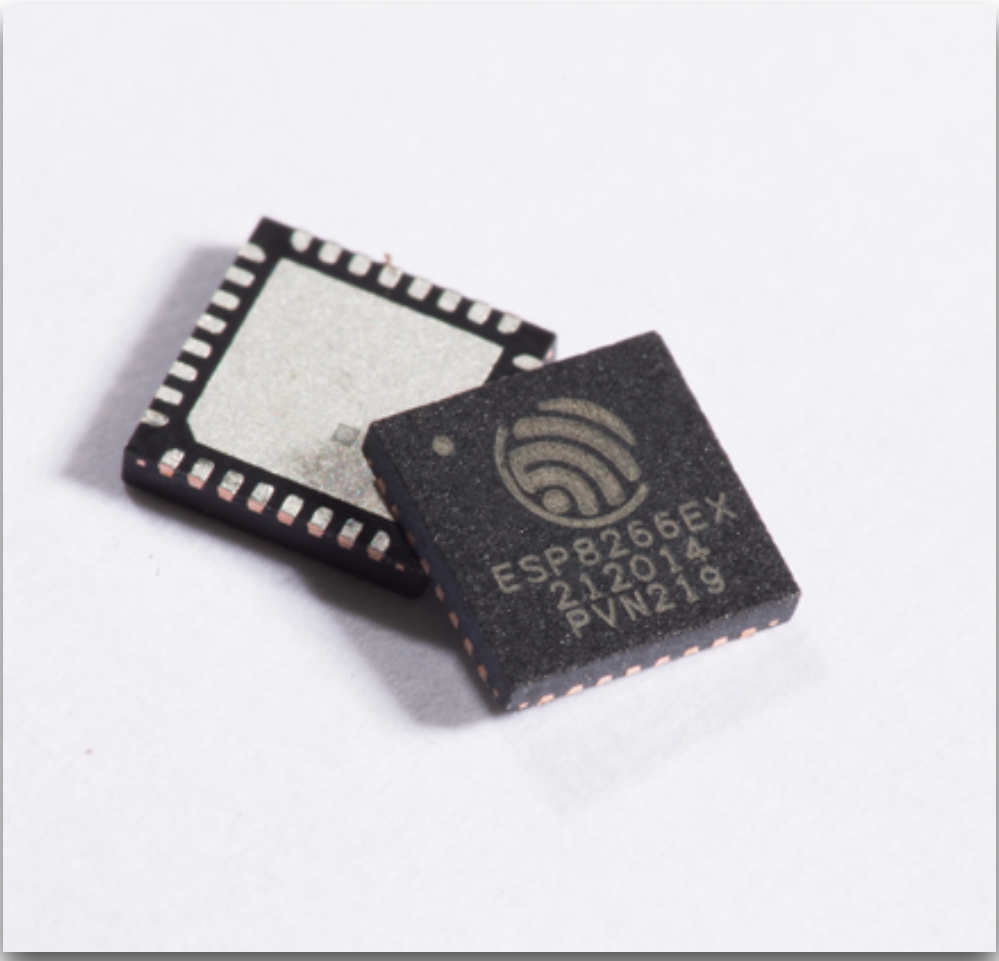



ESP-WROOM-02 Wi-Fi Module

ESP-WROOM-02 is an IoT Wi-Fi module that integrates the ESP8266, code flash memory, TCP/IP network stacks, low-power 32-bit MCU, 10-bit ADC, and HSPI/UART/PWM/I2S interfaces.

- ESP8266 consumes extremely low power, while providing wireless connectivity. For example, in DTIM10 mode, ESP8266 requires only **1.2 mW** with Wi-Fi on.
- ESP-WROOM-02 can be easily integrated into space-limited devices due to its small form factor of 18 mm x 20 mm only.
- The module supports an SPI flash with 16-Mbit or 32-Mbit memory for storing user programs and firmware.
- This module has gained SRRC (China) / FCC (US) / CE (EU) / TELEC (Japan) / KCC (South Korea) / IC (Canada) / NCC (Taiwan) certifications and has been exported worldwide.

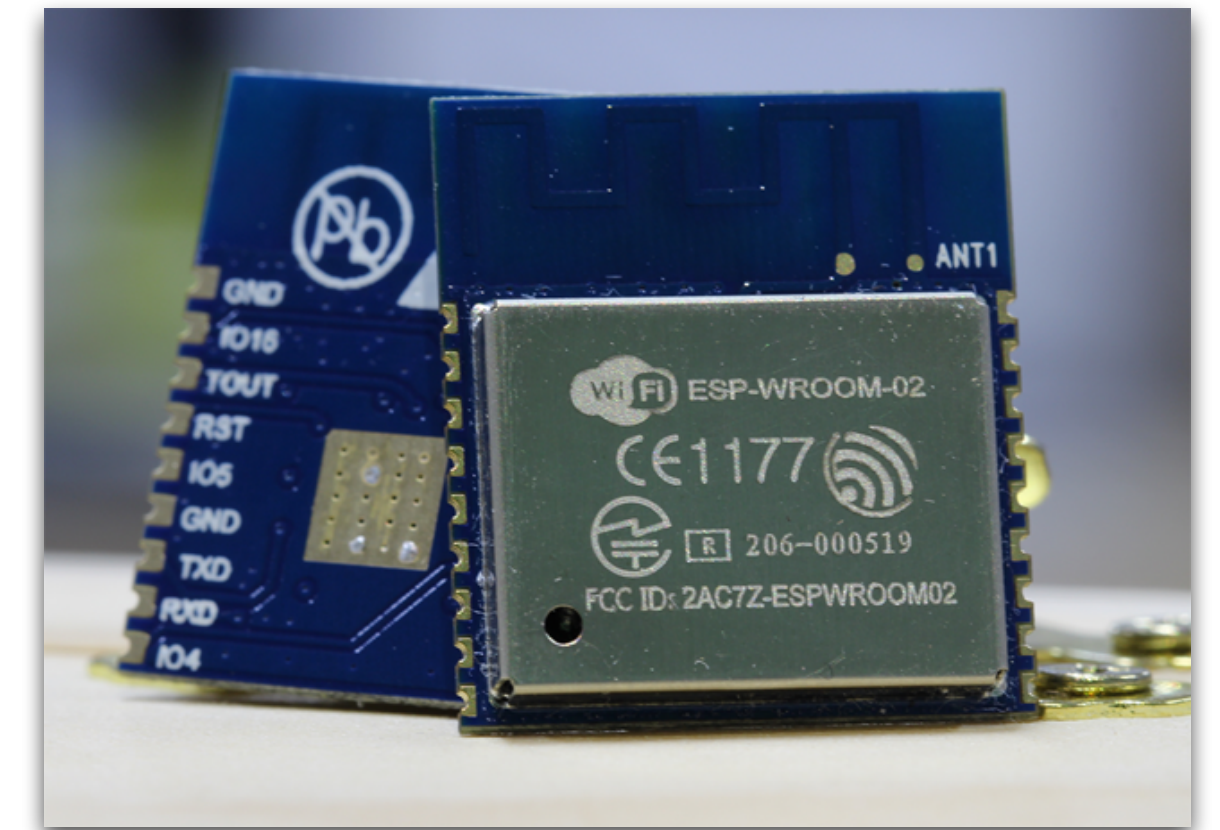



ESP-Launcher/ESP8266 Development Board

About ESP-Launcher

ESP-Launcher is a Micro USB-powered development board that allows access to all 32 pins of ESP8266. It integrates the commonly-used peripherals.

Multi-Purpose

ESP-Launcher can be used for testing chip functionalities or building Wi-Fi prototypes. It can also be used as a product testing tool.

Auto-Calibration

With the automatic calibration capability of ESP8266, ESP-Launcher can serve as a low-cost “golden sample” during the product testing period instead of costly calibration equipment.

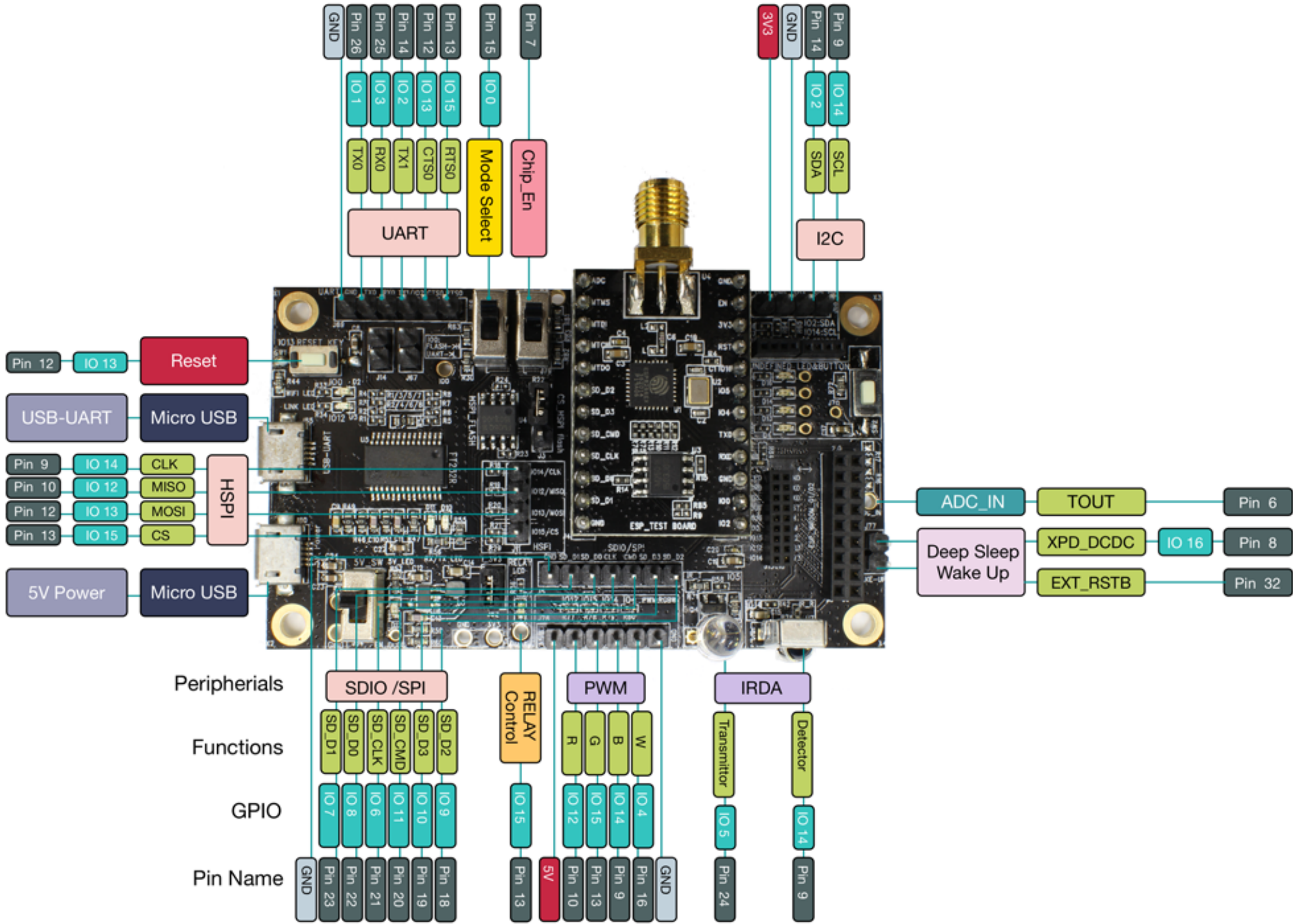



ESP8089 & ESP8689

- ▶ **ESP8089** is a highly-integrated 2.4 GHz Wi-Fi SoC, offering a complete Wi-Fi solution for devices that demand high-speed data transmission, such as tablets, STB, smart TV, etc.
 - The highly-integrated chip requires minimal external circuitry and PCB area, which lowers manufacturing cost.

- ▶ **ESP8689** integrates BT functionality, along with 2.4 GHz Wi-Fi functionality. Being a combo chip, it is suitable for use in tablets, set-top boxes, smart TVs, etc.

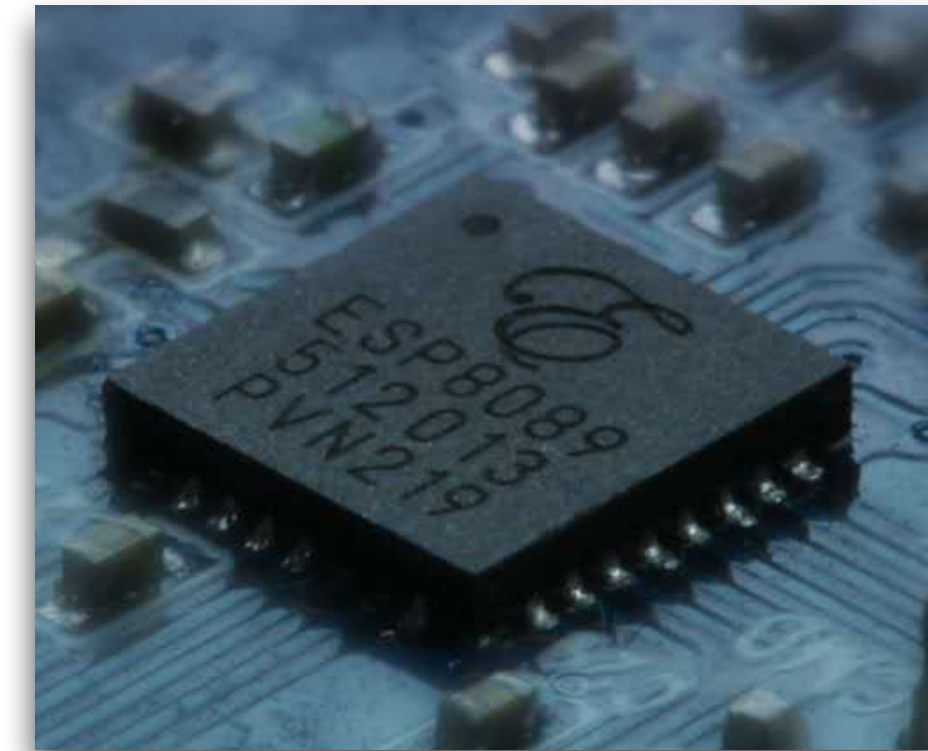



Selecting Espressif IoT Solutions

Application	#Devices	Chipset	Protocol	Data Rate	Range
Remote Controller	1	ESP8266	ESP-NOW	<10 kbps	<50m
Security Key Fob	1	ESP32	Wi-Fi + ESP-NOW	<10 kbps	100m
Intelligent Weighing Scale	<5	ESP32	Wi-Fi + BLE	<1 Mbps	<100m
Smart Lighting (Mesh)	100+	ESP8266 + ESP32	Wi-Fi + ESP-MESH + ESP-NOW	<1 Mbps	>100m
Home Automation	100+	ESP8266 + ESP32	Wi-Fi + ESP-MESH	~1 Mbps	>100m
Home Automation with Sensor Network	500+	ESP8266 + ESP32	Wi-Fi + ESP-MESH + ESP-NOW + BLE	~1 Mbps	>300m
Smart Lighting	<10	ESP8266	Wi-Fi	<10 Mbps	100m
Wi-Fi Camera	1	ESP32 + ESP8089	Wi-Fi HT40	~100 Mbps	<30m
Wi-Fi Audio	1	ESP32	Wi-Fi HT40 + BLE	~100 Mbps	<30m



ESP32 Audio Solution



Audio Boards

- **Quick** Boots up within two seconds
- **Touch** Supports touch buttons
- **Dual** Supports BT + Wi-Fi functionalities
- **Voice** Supports voice recognition
- **Mesh** Supports Mesh network for creating stereo sound

ESP32-Lyra**T** (touch pads)

ESP32-Lyra**P** (physical buttons)

- Supports various mainstream audio sources
- Supports AirPlay, DLNA
- Supports voice control on WeChat
- Supports microSD-card music playing



ESP Lighting Solution



ESP-MESH

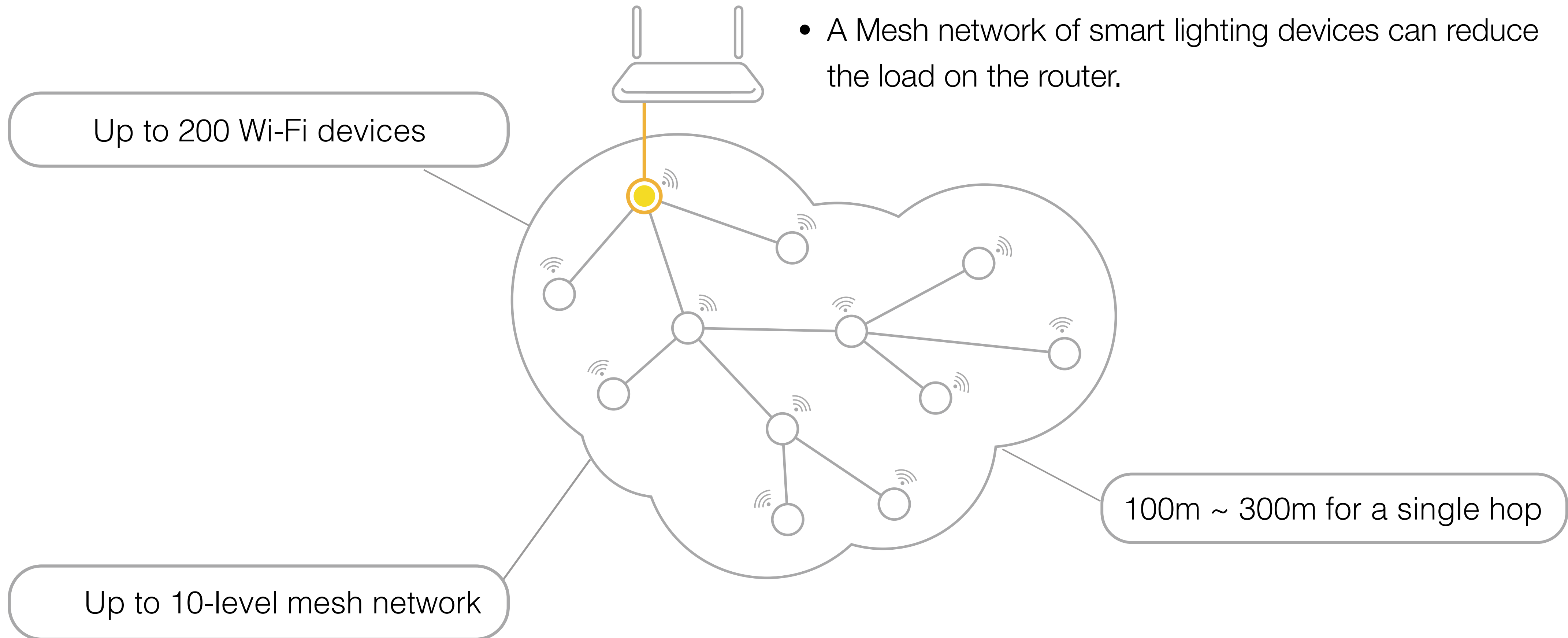



Espressif IoT Solutions



ESP-NOW

- Direct connection between devices
- No need to connect to router
- Low power
- Years of battery life



ESP-MESH

- Based on Wi-Fi
- No need for coexistence algorithm with Wi-Fi
- Higher reliability
- Larger scale of network coverage



ESP-PAIR

- Support for SmartConfig
- Easy to understand and configure



Contact Us

Business & Support

sales@espressif.com

Official Website

espressif.com

Developer Communities

bbs.espressif.com
esp32.com

WeChat Account



[@espressif](https://www.facebook.com/espressif)



[@EspressifSystem](https://twitter.com/EspressifSystem)



[@EspressifSystems](https://www.linkedin.com/company/EspressifSystems)